

# PSE 31x/33x-14

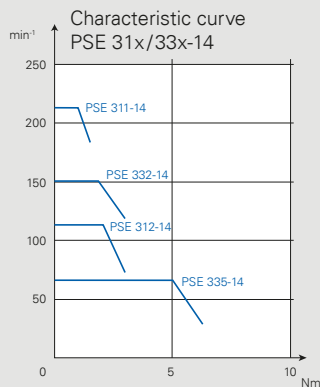
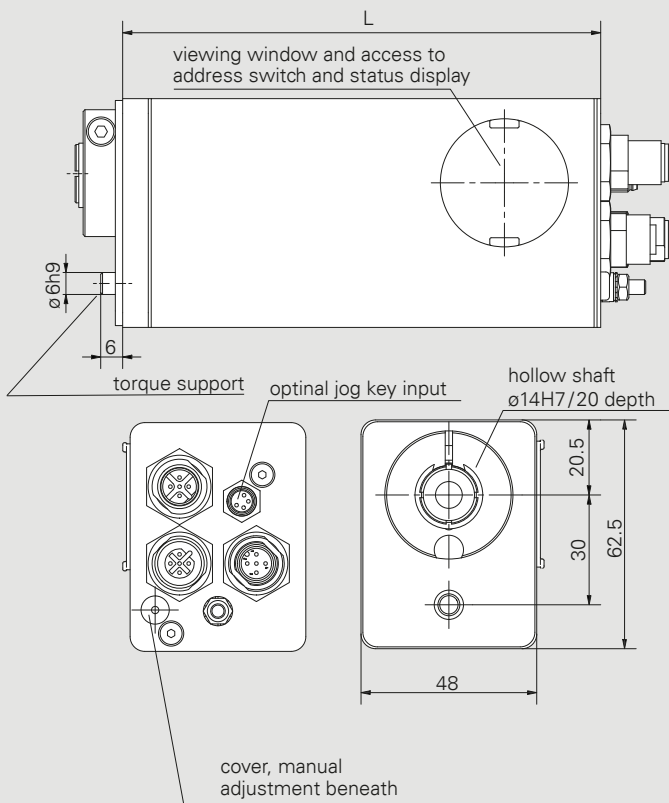

Protection class	L
54	125
65	131

Dimensions in mm.  
For details of the connections please see also the instruction manual.

Product	Nominal torque (x)	Self-holding torque (energized)	Nominal rated speed
PSE 311-14	1 Nm	0.5 Nm	210 min <sup>-1</sup>
PSE 312-14	2 Nm	1 Nm	115 min <sup>-1</sup>
PSE 332-14	2 Nm	1 Nm	150 min <sup>-1</sup>
PSE 335-14	5 Nm	2.5 Nm	68 min <sup>-1</sup>

Duty cycle	30% (basis time 300s)
Mode of operation	S3
Supply voltage	24 VDC $\pm 10\%$ galvanically separated between control and motor and bus
Rated current	PSE 31x: 2.5 A, PSE 33x: 3.2 A
Power consumption (control unit)	0.1 A
Positioning accuracy absolute measurement of position taken directly at the output shaft	0.9°
Positioning range	250 rotations <sup>2)</sup> not subject to mechanical limits
Shock resistance in accordance with IEC/DIN EN 60068-2-27	50 g 11 ms
Vibration resistance in accordance with IEC/DIN EN 60068-2-6	10..55 Hz 1.5 mm/ 55..1 000 Hz 10 g/ 10..2 000 Hz 5 g
Output shaft	14 mm hollow shaft with clamp ring
Brake	optional (holding torque=nominal torque)
Max. axial force	20 N
Max. radial force	40 N
Ambient temperature	0..45 °C
Storage temperature	-10..70 °C
Protection class	IP54 or IP65
Housing	Aluminum, Zinc
Weight	850 g
Certificates	CE, optional: NRTL, optional: STO with/without test pulses <sup>1)</sup>

<sup>1)</sup> STO: only for EtherCAT, EtherNet/IP, POWERLINK, PROFINET, without galvanic separation of the supply voltage

<sup>2)</sup> With PSx 3xx with IO-Link, the travel range can be increased by a multiple of the absolute measuring range of 256 revolutions and a partial absolute travel range of over 500,000 revolutions can be realized.



# How to choose your suitable positioning system?



To order our standard products, you can use the graphics on the right for an initial performance assessment of the products and the corresponding order code of the 3 series. The ordering process is described below using an example.

- A** Choose the appropriate **design** based on your operating conditions
- B** **Type:**
  - Vertical or horizontal form (value even or odd)
  - max. rated torque (x) - for orientation see characteristic diagrams
  - Output shaft (8 or 14) and solid or hollow shaft
- C** select required protocol / interface (**bus communication**)
- D** integrate the **connections** that are essential for you
- E** if necessary, select a **brake** (without brake select 0)
- F** select required **certificates**
- G** select **IP protection class**

For example, a stainless steel housing (PSW), the 30x design, a maximum rated torque of 2 Nm and an 8 hollow shaft would be required (302-8). Besides IO-Link, the standard connections are required, no brake, the CE certificate and IP65.

→ Order code **PSW 302-8-IO-0-0-0-65**

## Torques and speeds

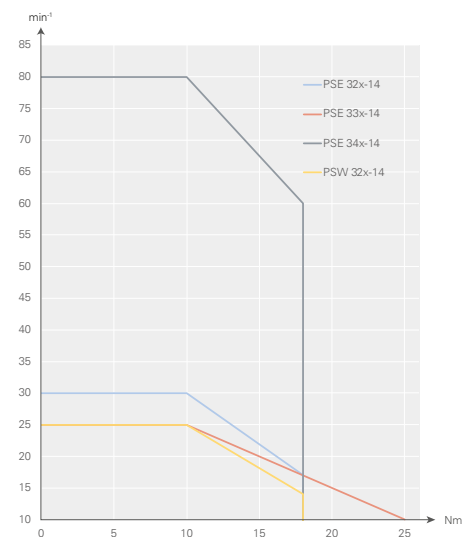
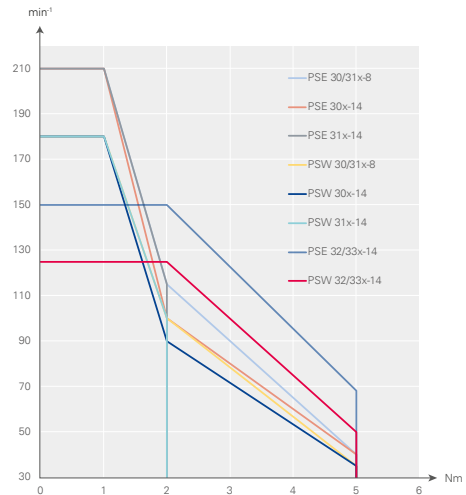



## Order code PSE / PSW 3 series



	A Design	B Type	C Bus communication	D Connections	E Brake	F Certification	G IP protection class
Positioning System <b>Efficient</b>	PSE	30x-8 30x-8 V 30x-14 30x-14 V 31x-8 31x-8 V 31x-14 31x-14 V	CA: CANopen DP: PROFIBUS DP DN: DeviceNet <sup>1)</sup> MB: Modbus RTU <sup>1)</sup> SE: Sercos EC: EtherCAT PN: PROFINET	0: Standard <sup>2)</sup> T: Standard with jog keys <sup>1)</sup> X: Plug-in, L-coded <sup>1)</sup> Y: Plug-in, Y-coded <sup>1)</sup> Z: Plug-in, Y-coded, with jog keys <sup>1)</sup>	0: without M: with <sup>3)</sup>	0: CE N: NRTL + CE S: STO + CE without test pulses <sup>1)</sup> T: STO + CE with test pulses <sup>1)</sup> Y: STO + NRTL + CE without test pulses <sup>1)</sup> Z: STO + NRTL + CE with test pulses <sup>1)</sup>	54: IP 54 <sup>1)</sup> 65: IP 65 <sup>1)</sup> 68: IP 68 <sup>4)</sup>
Positioning System <b>Washable</b>	PSW	32x-14 32x-14 V 33x-14 33x-14 V 34x-14 <sup>5)</sup>	EI: EtherNet/IP PL: POWERLINK IO: IO-Link				

Form/Type	Torque	Output shaft
30  horizontal	<b>x</b> = 1 Nm	8 = 8 mm hollow shaft 14 = 14 mm hollow shaft
31  vertical	<b>x</b> = 2 Nm	
32  horizontal	<b>x</b> = 5 Nm	8V = 8 mm solid shaft <sup>1)</sup> 14V = 14 mm solid shaft <sup>1)</sup>
33  vertical	<b>x</b> = 10 Nm	
34  horizontal	<b>x</b> = 18 Nm	
	<b>x</b> = 25 Nm <sup>5)</sup>	

<sup>1)</sup> Not available as standard for all versions / bus communication.

Please contact our sales department.

<sup>2)</sup> The standard is 3 plugs / sockets (except for IO-Link or Y-coded connector)

<sup>3)</sup> only for variants with 14 mm output shafts

<sup>4)</sup> only for PSW

<sup>5)</sup> only for PSE









Please refer to the data sheets for the respective standard combinations.

To place your order, please call us at  
**+49 7661 3963-0** or email us at  
**info@halstrup-walcher.com.**  
 For additional contacts, please visit  
**www.halstrup-walcher.de/en/contact**

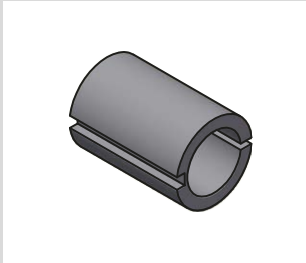
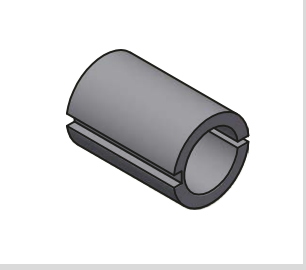
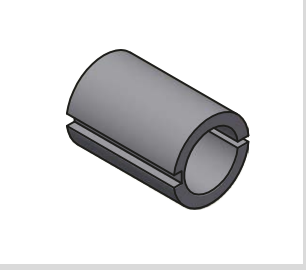
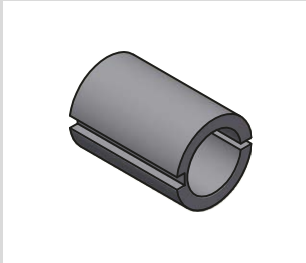

# Accessories for our positioning systems

The connectors shown here can be used for all device types (PSE / PSW). With PSE (IP 54 / IP65), this guarantees the IP protection classes. If required, we are happy to help you find a suitable connector for a PSW (IP 68) - please contact us.

Buscommunication	Power supply (+ databus connector) (for option 0) <sup>1)</sup>	Power supply + databus + jog key connector	On request		
CANopen	 <p>Connector set: Order no. 9601.0060  <b>For PSE 34xx</b>  Connector set: Order no. 9601.0093</p>	 <p>Connector set: Order no. 9601.0062</p>	<p><b>Cable</b></p> 		
PROFIBUS DP				Modbus RTU	<p><b>Reducing sleeve</b> for adaptation to different spindle diameters</p> 
DeviceNet				 <p>Connector set: Order no. 9601.0088</p>	 <p>Connector set: Order no. 9601.0090</p>
Sercos	 <p>Connector set: Order no. 9601.0112</p>	 <p>Connector set: Order no. 9601.0317</p>	<p><b>Reducing sleeve</b> for adaptation to different spindle diameters</p> 		
EtherCAT			POWERLINK	<p><b>Reducing sleeve</b> for adaptation to different spindle diameters</p> 	
PROFINET			EtherNet/IP	<p><b>Reducing sleeve</b> for adaptation to different spindle diameters</p> 	
IO-Link	 <p>Connector: Order no. 9601.0107</p>				

<sup>1)</sup> see in order code under D

Screw cap to cover the second bus connection (for PSE/PSW). Not suitable for PSE with IE interface.

**Order no. 9601.0176**



Jog key box  
(for Option T in section D of the Order code)

**Order no. 9601.0241**

## Software

Use our function blocks, description files or commissioning tools for the various industrial protocols. You can download the files under [www.halstrup-walcher.de/en/software](http://www.halstrup-walcher.de/en/software). To do this, enter your specific product in the drop-down menu that appears and select the Software tab in the tab view. After that, the software components are available to you.

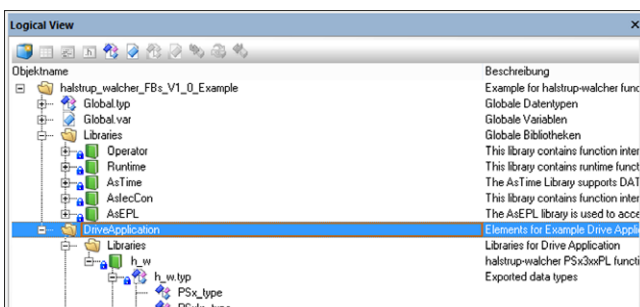

## You want to see our products in person?

We are represented at numerous trade fairs and will be happy to advise you. Visit us on site and let us find the ideal solution together. You can find our current exhibition dates and product news at:



[www.halstrup-walcher.de/en/news/](http://www.halstrup-walcher.de/en/news/)